

User Manual for
TeraRanger Evo Thermal with:
USB and UART backboards



Evo Thermal 90



Evo Thermal 33

Table of contents

1. Introduction	3
2. Mechanical integration	4
2.1. Mechanical design	5
2.2. Sensor handling during system assembly	6
3. USB backboard use	7
3.1. Graphical User Interface	7
3.1.1. Prerequisites	7
3.1.2. Basic operation	7
3.1.3. Custom emissivity settings	13
3.1.4. Firmware upgrade	14
4. UART backboard use	15
4.1. UART interface	15
4.2. Backboard LEDs	16
4.3. Electrical characteristics	16
5. Communication	17
5.1. UART protocol information	17
5.2. USB protocol information	17
5.3. Commands	17
5.4. UART / USB output format	18
5.5. CRC32 checksum reconstruction	20
6. Compliance	22
Appendix	23
A.1. CRC validation	23
A.1.1. How to calculate CRC8 checksum for Evo Thermal	23
A.1.2 How to calculate CRC32 checksum for Evo Thermal	23
A.2. Sample code	24

1. Introduction

The purpose of this document is to give guidelines for use and integration of the TeraRanger Evo Thermal sensors with (a) UART backboard, and/or (b) USB backboard using these standard communication interfaces.

1.1. About TeraRanger Evo Thermal

TeraRanger Evo Thermal is the thermographic addition to the TeraRanger Evo sensor family. It provides a 32 x 32 pixel resolution in a compact and affordable design, available in 2 versions.



Figure 1. TeraRanger Evo Thermal two versions

Evo Thermal 90 benefits from a wide 90 degree Field-of-View for monitoring larger areas. The sensor also has a smaller and lighter design (10 grams).

Evo Thermal 33 offers longer range, higher sampling rate (7 Hz) and a more detailed thermal image because of the narrower Field-of-View.

By using passive infrared thermal technology, Evo Thermal sensors operate in a broad range of conditions including indoors, outdoors, sunlight, complete darkness and poor visibility. Because thermal data does not reveal identity, personal privacy is at all times protected.

To learn more about sensor technical specifications, please see [TeraRanger Evo Thermal Specification sheet](#).

2. Mechanical integration

The mechanical design of the main sensor module (black) allows easy assembly to its backboard (yellow) using a simple 'clip-in' technique. When you clip the two together, ensure there is no visible gap between the black and yellow parts. The yellow backboard has two mounting holes for final installation. Please reference [Figure 2](#) for visual instructions.

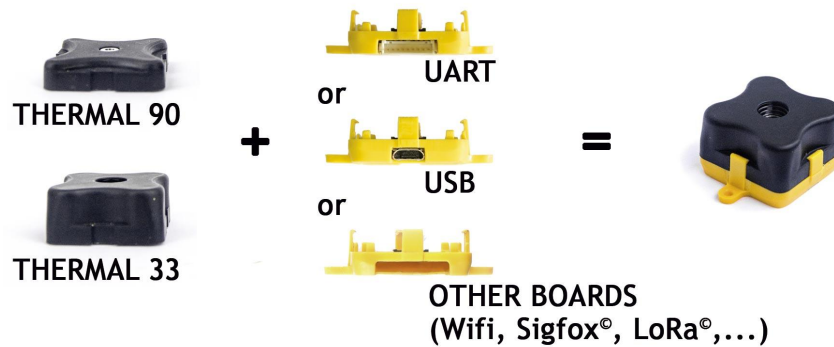

Figure 2. TeraRanger Evo two-part design

When choosing a place for mounting, please consider the following recommendations:

- Choose a place which is in accordance with the optical constraints listed below
- Mounting close to sources of heat or strong electromagnetic fields can decrease the sensing performance
- Do not mount anything directly in front of the sensor or in a cone of approximately $\pm 90^\circ$ around the central optical axis of the sensor
- Please consider that dust, dirt and condensation can affect the sensor's performance
- To obtain a correctly positioned (not inverted or rotated) thermal image, please mount the sensor with the USB or UART connector pointing left (if facing sensor's lens). See [Figure 3](#) for visual instructions. This also applies when hand-testing Evo Thermal via our graphical user interface (see [Section 3.1.2.](#)).

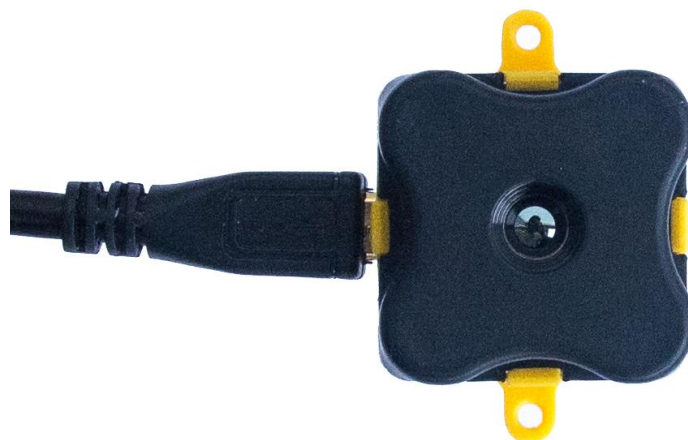

Figure 3. Module orientation for correct thermal image. Evo Thermal 33.

2.1. Mechanical design

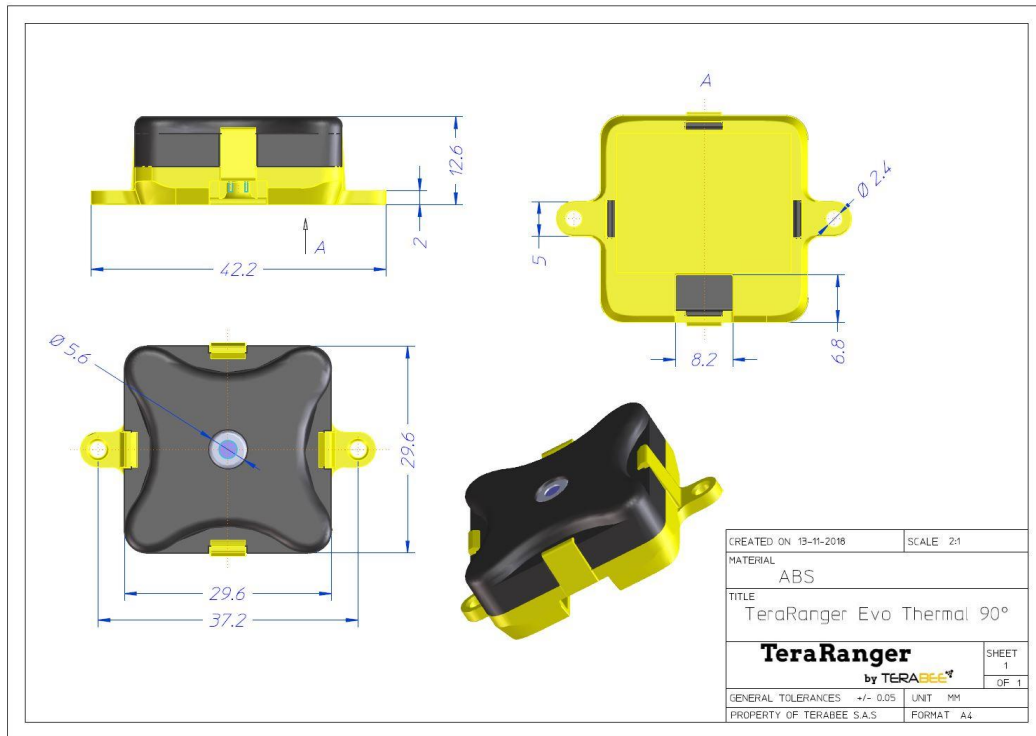

Figure 4. Evo Thermal 90 external dimensions

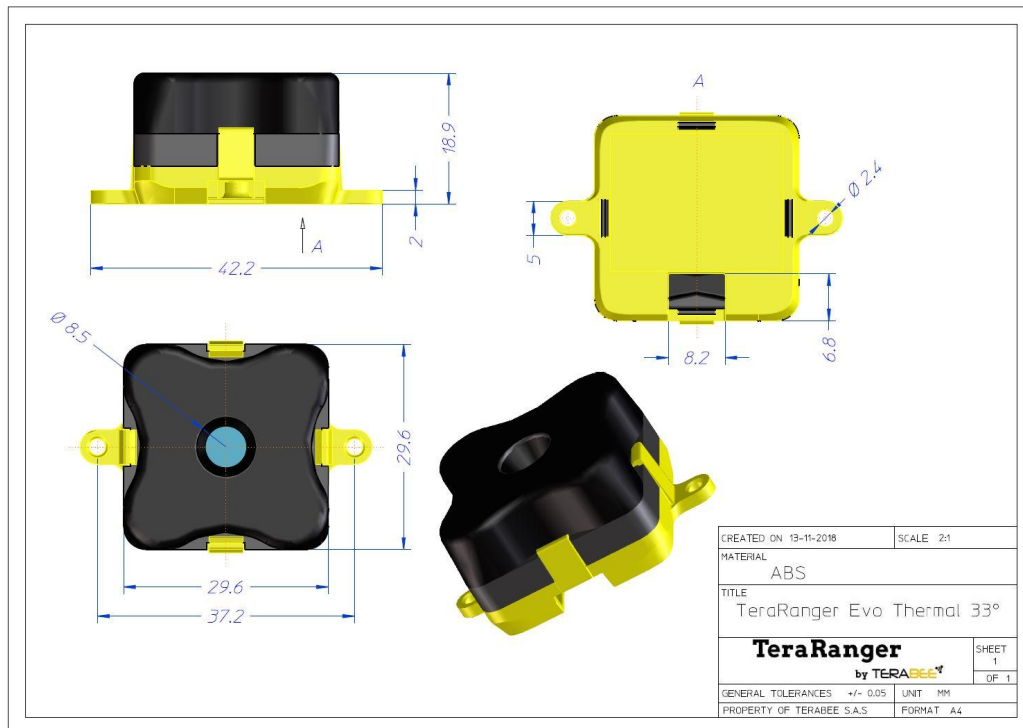

Figure 5. Evo Thermal 33 external dimensions

2.2. Sensor handling during system assembly

During assembly and integration, please observe all common ESD precautions. All optical surfaces (sensor front) should be kept clean and free from contact with chemicals.

3. USB backboard use



The USB backboard comes with a standard Micro-USB connector.

3.1. Graphical User Interface

A free Graphical User Interface (GUI) is available, providing an easy way to visualize the data from your TeraRanger Evo Thermal sensor. This is useful for demonstration, testing purposes and checking some of the basic parameters of the sensor. It also provides an option to easily record thermal images, export raw data and upgrade the firmware running on the device.

The GUI is available for download here: [GUI Download](#). (See “Downloads” section of the [TeraRanger Evo Thermal product page](#)).

3.1.1. Prerequisites

For usage on Windows 7 and Windows 8, please download the Virtual COM Port driver from <http://www.st.com/en/development-tools/stsw-stm32102.html> and **follow the “ReadMe file” instructions given by the installer**. After successful installation, unplug the interface for a few seconds, and plug it back in. The virtual COM port should now be available on your PC.

Users of Windows 10 do not need to download this driver as the built in Windows driver is recommended.

3.1.2. Basic operation

During installation of the GUI, you might receive a notification from Windows about an unknown application trying to start ([Figure 6](#)). In the “Windows protected your PC” screen select **More info > Run anyway** to proceed with Evo Thermal GUI installation and please be advised that running this application will not put your PC at risk.

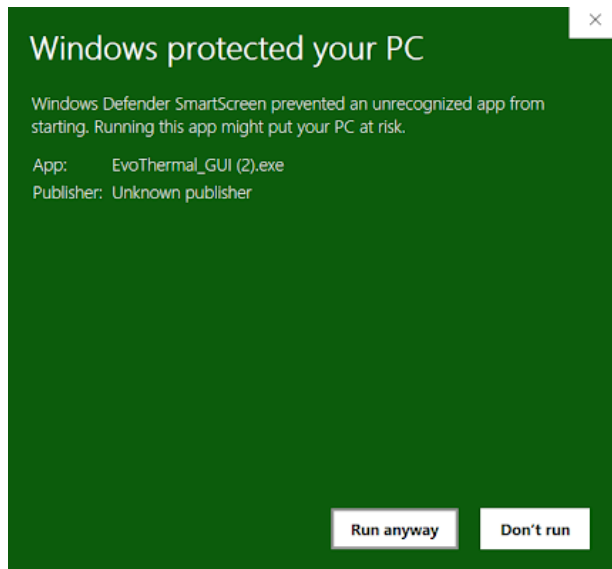

Figure 6. Windows protection screen during installation

After successful installation, make sure your TeraRanger Evo Thermal is connected to a USB port on your computer. In the GUI select **File > Connect (Ctrl+C)**. You will immediately see thermal data displayed in a 32x32 pixel color map (Figure 7) on the left side of the GUI. For the purposes of this instruction, Evo Thermal 33 sensor has been used.

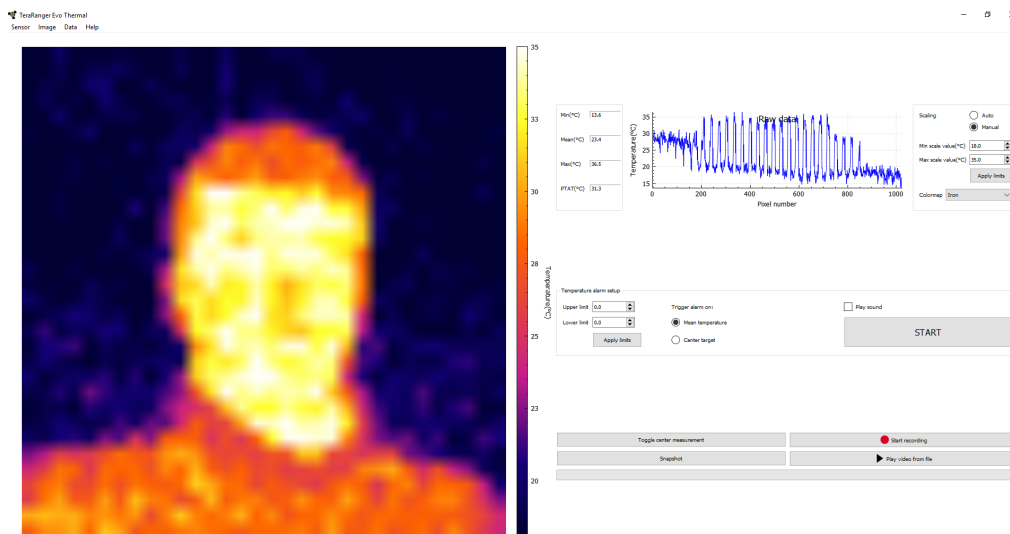

Figure 7. Graphical user interface: home screen

By default, on each new connection, temperature readings in the GUI will be displayed in Celsius units. To modify measurement units in real-time, select **Data > Temperature Units** and choose to present data also in Kelvin and Fahrenheit (Figure 8).

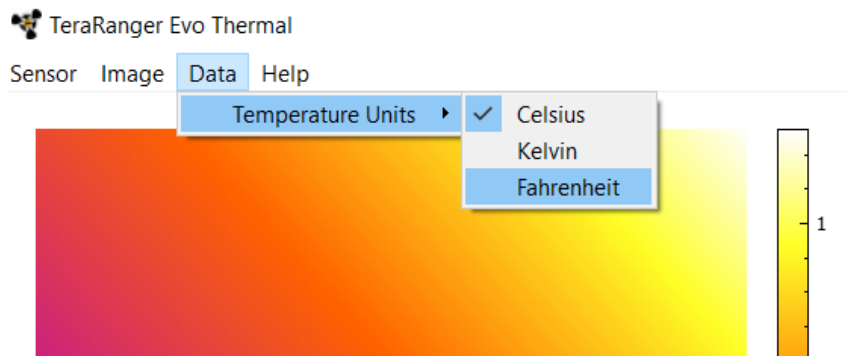

Figure 8. Setting temperature units in GUI

On the right side of the depth map you will find a color vs temperature scale. By default the scale will be automatically adjusted depending on the highest and lowest temperature values detected in the sensor's Field-of-View at time of data capture. To set custom temperature bounds, in the **Scaling** field (Top right) select **Manual** and you should now be able to input minimum and maximum temperature bounds. Select **"Apply limits"** to apply changes, and the scale will adjust according to the set values. To switch back to automatic temperature scaling, select **Auto**. See [Figure 9](#) for visual instructions.

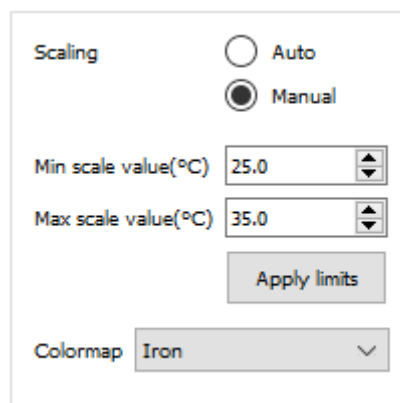

Figure 9. Scaling field

The GUI also offers the option to display the temperature readings in one of 4 colormaps. To do this, in the **Scaling** field, select **Colormap** and from the dropdown menu choose between the following colormaps: **Iron**, **Rainbow**, **High Contrast** and **White hot**. The temperature map will change automatically once a colormap is selected ([Figure 10](#))

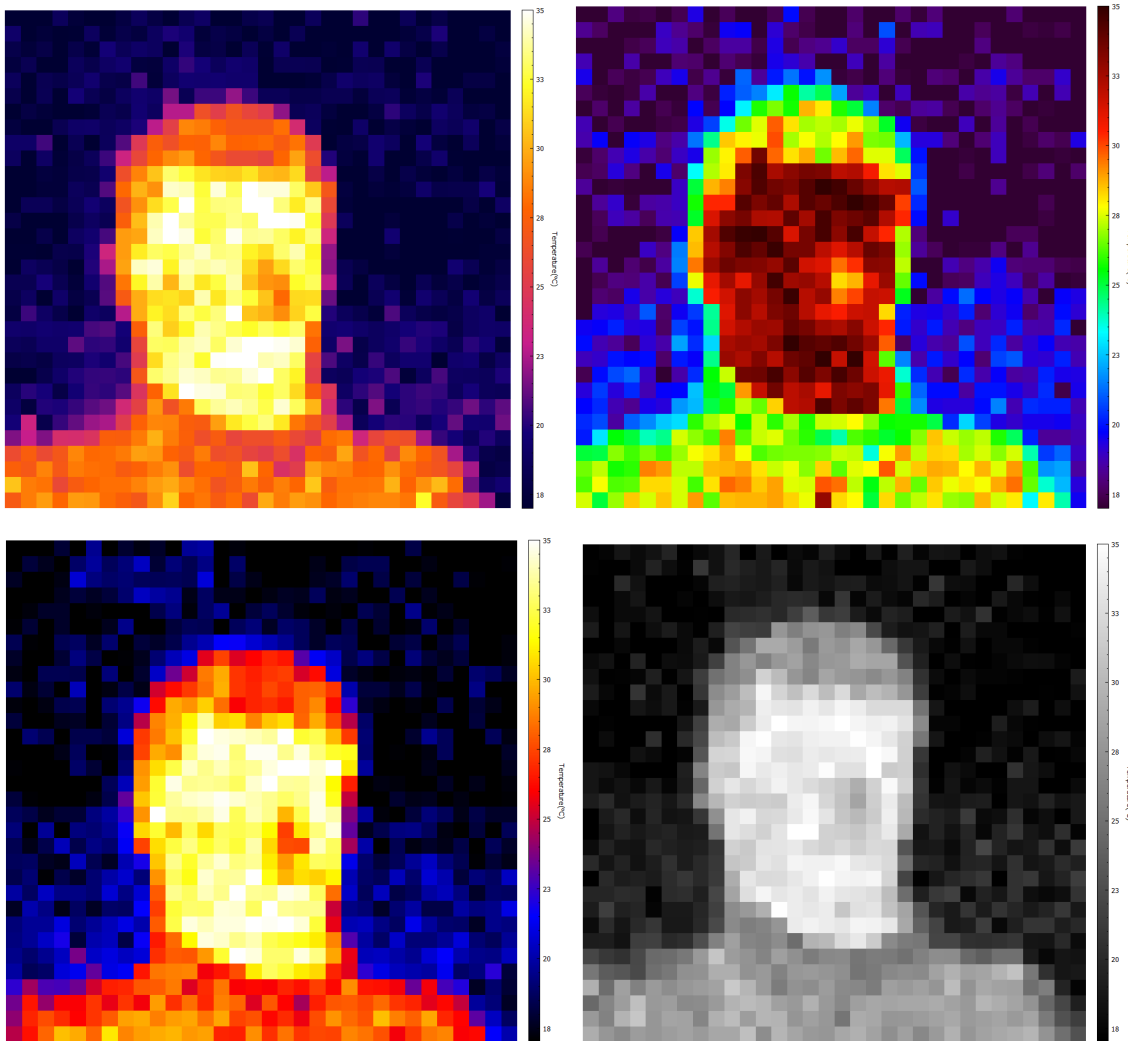

Figure 10. Colormaps: Iron (top left), Rainbow (top right), High Contrast (bottom left), White hot (bottom right).

On the main interface, you will also find basic parameters of the Evo thermal sensor adapting in real-time to the measuring environment. These values include:

- Minimum temperature value (Min),
- Mean temperature value (Mean),
- Maximum temperature value (Max),
- Proportional to Absolute temperature (PTAT).

A visual 2-axis graph on the main interface of the GUI illustrates temperature patterns in real time over all 1024 pixels of the Thermal sensor (Figure 11). This provides a quick temperature spread overview of objects measured within the sensor's Field-of-View.

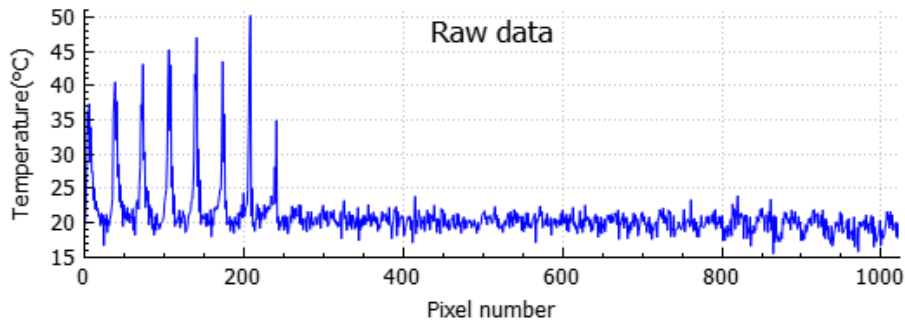

Figure 11. Real-time temperature distribution of pixels

Evo Thermal GUI also allows setting temperature limits and enabling warning notifications once thresholds are breached. In the **Temperature alarm setup** section, first select upper and lower temperature limits and click **Apply limits** to confirm. Next, choose the method for triggering the alarm: (1) based on mean temperature or (2) heat measured at the center of target. An option for adding an audio alert is also available. After all parameters are set, click **Start** to initiate the alarm function (Figure 12).

Figure 12. Setting alarm for temperature breach

At the bottom of the GUI, **Toggle center measurement** feature enables measuring the temperature of the central part in the thermal map. A rectangular crosshair will be drawn in the center of the thermal map, encompassing 4 pixels. Simultaneously, a small text field will appear in the top center region to display a temperature value, which is an average of the 4 pixels. To disable the center measurement feature, click the Toggle center measurement button again.



Figure 13. Toggle center measurement and Snapshot features

The Evo Thermal GUI also allows the user to capture and save screenshots of the 32x32 thermal map in real time. To do this, click **Snapshot**. A confirmation message alongside the storage location will be displayed at the bottom left corner of the GUI's window.

Record function (bottom of GUI) offers to register recordings of the GUI thermal map. Select **Start recording** and you will be asked to choose and save the file in a location of your choice. After storing the file (.txt format), recording will start automatically. To disable recording select **Stop recording**. Please note that temperature data is saved in deciKelvins with the following format:

Pixel 0, Pixel 1, Pixel 2... Pixel 1023, PTAT followed by a newline character.



Figure 14. Record and Playback features

To playback your recordings, select **Play video from file** and choose a previously created and saved .txt format file. Next, a window will appear asking to select the speed of playback. Choose between: 7Hz, 14Hz or 30Hz and click OK to initiate the playback. **Pause** and **Stop** options are also available. Please note that other features of Evo Thermal GUI, such as manual scaling, interpolation, snapshot, etc., can also be used during playback.

By default, the temperature readings visualized in the image are in discrete mode. To interpolate pixels, select **Image > Interpolate** (Figure 15). To turn off interpolation of temperature readings and switch back to discrete mode select again **Image > Interpolate**.

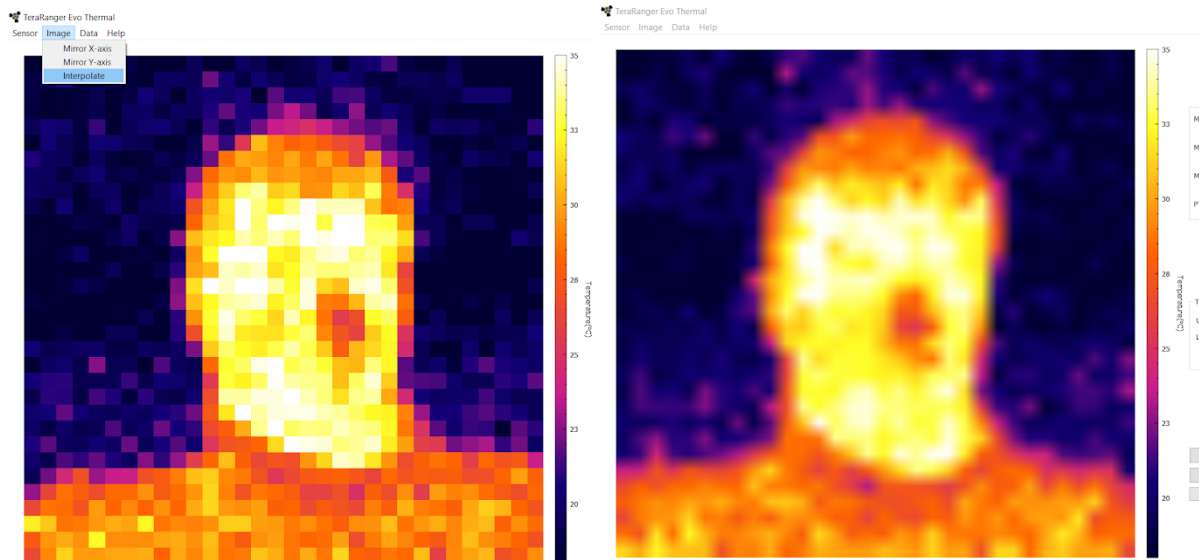

Figure 15. Interpolated vs discrete mode

The GUI also offers an option to mirror the X and Y axis of the thermal map. To enable this feature, select **Image > Mirror X / Mirror Y** to flip the horizontal or vertical axis of the thermal map.

Once you are done with testing the sensor, in the GUI select **File > Disconnect (Ctrl+D)**, the GUI will terminate its VCP connection with the sensor.

3.1.3. Custom emissivity settings

For measuring materials with lower emissivity levels, the GUI allows setting custom sensor emissivity. Please note that this is an advanced feature recommended only for experienced users. For accurate temperature measurements, note that the sensor's emissivity has to match your target's emissivity level. Setting the wrong sensor's emissivity can result in an increased accuracy error.

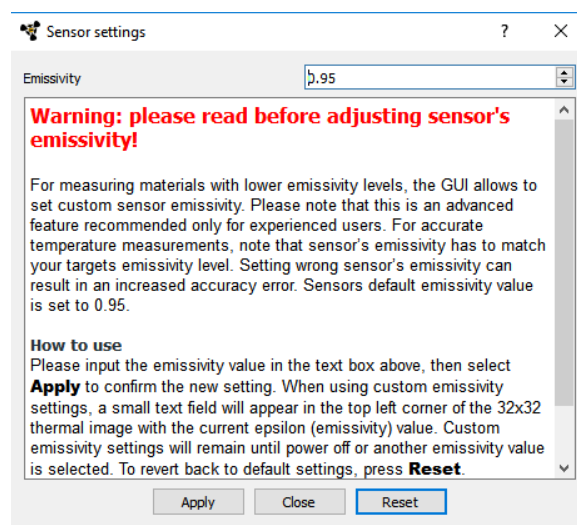

Figure 16. Custom emissivity settings

Sensors default emissivity value is set to 0.95. To adjust emissivity, on the top bar menu, select **Sensor > Settings**. A window will now open offering usage instructions and a text field to adjust sensor's emissivity (Figure 16). Once adjusted, select **Apply** to confirm the new emissivity value. When using custom emissivity settings, a small text field will appear in the top left corner of the 32x32 thermal image with the current epsilon (emissivity) value. Custom emissivity settings will remain until power off or another emissivity value is selected. To revert back to default settings, from the same window, press **Reset**. Please note that for measuring materials below emissivity 0.60, temperature accuracy can vary.

3.1.4. Firmware upgrade

It is possible to upgrade the firmware running on your device if a new firmware version is made available on the Terabee website. The current firmware version on your TeraRanger Evo can be found by selecting **Help > About** in the graphical user interface.

Please note the Upgrade Firmware feature is only supported on Windows 7, 8 and 10. Please carefully follow the steps outlined below to avoid permanently disabling your device.

- Install the latest version of the TeraRanger Evo GUI on your computer available on the "Download" section of Evo Thermal product page of Terabee website.
- Download the latest firmware file from the Terabee website
- In the GUI Select **File > Connect** and then **File > Upgrade Firmware**
- You will be presented with a dialog window asking you to confirm your choice
- After confirming your choice, a new dialog window will present you with instructions on selecting the firmware file and launching the upgrade process, read the instructions carefully.
- Press **Select File** and select the new firmware file with Windows File Explorer
- Press **Upgrade** and wait until the operation finishes
- **DO NOT** disconnect the device while the upgrade is in progress. Once the upgrade is complete, the dialog box will close itself

4. UART backboard use

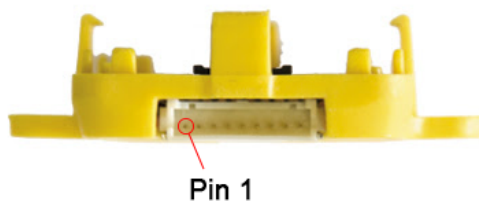

4.1. UART interface

The TeraRanger Evo Thermal can be controlled through the UART interface. It uses a single 9 pin Hirose DF13 connector for interfacing to the host system. The mating connector is a Hirose DF13-9S-1.25C with crimping contacts DF13-2630SCF (tin) or DF13-2630SCFA (gold). Please consider the mechanical stability of the mated connectors and avoid any kind of excess force on the connector (during installation and once integrated) and follow the recommendations in the Hirose DF13 series datasheet (available here: <https://www.hirose.com/product/en/products/DF13>) to ensure a reliable connection.

The table below provides an overview of the pin out of the DF13 connector:

Pin out and description (According to DF13 datasheet)

Pin	Designator	Description
1	Tx	UART transmit output. 3.3V logic
2	Rx	UART receive input. 3.3V logic
3	GND	Power supply and interface ground
4	rfu	RESERVED FOR FUTURE USE
5	rfu	RESERVED FOR FUTURE USE
6	rfu	RESERVED FOR FUTURE USE
7	5V	+5V supply input
8	GND	Power supply and interface ground
9	rfu	RESERVED FOR FUTURE USE

4.2. Backboard LEDs

Five LEDs are mounted to give visual feedback on the sensor. Table below lists the functionality of each LED:

LED	Description
PWR (orange)	Power indicator, on when 5 V connected
Rx/Tx (green / red)	UART receive and transmit indicators
LED 0 / LED 1	For internal use only

4.3. Electrical characteristics

DC electrical characteristics

	Parameter	Minimum	Standard	Maximum
Power supply	Voltage input	4.75 V	5 V	5.25 V
	Current consumption	45 mA		
Interface logic levels (referenced to +3V3)	LOW	-		1
	HIGH	2.3		-

5. Communication

5.1. UART protocol information

The UART communication for the TeraRanger Evo Thermal uses a simple protocol via UART depending on the backboard used with the sensor.

For TeraRanger Evo Thermal sensors with a firmware version up to and including 1.1.0 STD level, the communication parameters for UART are:

Baud Rate: 1500000
Data Bits: 8
Stop Bit(s): 1
Parity: None
HW Flow Control: None

For TeraRanger Evo Thermal sensors with a firmware version 1.2.0 STD level and above - shipment dates from July 2020 onwards - the communication parameters for UART are:

Baud Rate: 460800
Data Bits: 8
Stop Bit(s): 1
Parity: None
HW Flow Control: None

You can refer to [Section 3.1.4](#) to learn how to check the firmware level of a sensor.

5.2. USB protocol information

The USB communication for the TeraRanger Evo Thermal uses a simple protocol via USB depending on the backboard used with the sensor. The communication parameters for the USB VCP are:

Baud Rate: 115200
Data Bits: 8
Stop Bit(s): 1
Parity: None
HW Flow Control: None

5.3. Commands

The user can send commands to activate or deactivate the USB output of the sensor. The frame of the command is built concatenating 8 bit address of the TeraRanger Evo Thermal, 4 bit Command (CMD) code, 4 bit for data count (indicating how many bytes of

data will follow), N bytes of the data itself and a CRC-8 (8 bit) checksum of the entire frame in the last byte. The frame layout is depicted in [Figure 17](#).



Figure 17. Frame structure for Evo Thermal commands

The table below lists all commands, including address and CRC-8, that can be sent to the sensor:

Command Name	Command Description	Command
Deactivate VCP Output	Deactivate USB VCP Output	0x00 52 02 00 D8
Activate VCP Output	Activate USB VCP Output	0x00 52 02 01 DF
Set custom emissivity	Change emissivity to user input	0x00 51 AA BB*

*AA is emissivity value in hexadecimal format from 1 to 100; and BB is CRC8 that varies depending on AA value

NB: Each command MUST be transmitted in a continuous stream ie. not byte by byte.

The TeraRanger Evo Thermal will reply to the above commands with a four byte response. The third byte of the response will contain either an ACK (0x00) or a NACK (0xFF) to indicate if the sensor has acknowledged or not acknowledged the command. In the case of the UART interface, the sensor will tolerate moderate buffer overruns but it is advisable to always wait for a command reply before sending a new command.

5.4. UART / USB output format

By default, TeraRanger Evo Thermal by outputs **calibrated temperature data in deci Kelvins**. When connected via UART, the sensor will immediately start outputting data on startup. **However when connected via USB, it is necessary to send the ACTIVATE USB OUTPUT command as shown in commands table ([Section 5.3](#)).**

Each frame contains the following output structure:

- a 16 bit header;
- 1024 pixel values;
- the sensor's internal temperature;
- 7 pad values of 0x0000
- a CRC32 to ensure the data integrity on the transmission.

Each value is represented on a 16 bit unsigned integer word that is transmitted in little endian format (least significant bit first). Total packet length is 2070 bytes per frame, as depicted in [Figure 18](#).

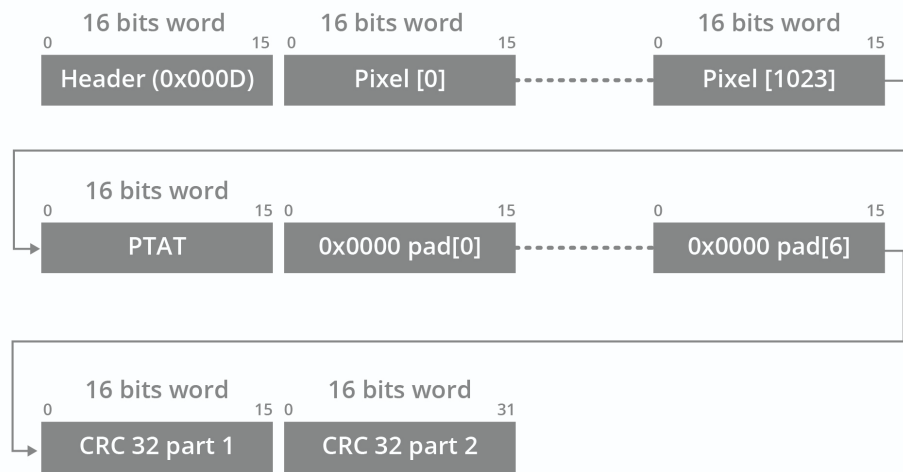

Figure 18. Evo Thermal output format structure

The size of every frame transmitted by the sensor is a multiple of 4 therefore 7 pad values of 0x0000 are appended.

Each frame contains a CRC32 checksum to allow the end user to confirm data integrity. The CRC32 used is CRC-32 MPEG 2 (Polynomial 0x4C11DB7 with initial value of 0xFFFFFFFF and Final Xor Value 0x0).

Please reference [Appendix](#) for instructions on the following topics:

- CRC validation
- Sample code for reading data from Evo Thermal sensor (link to GitHub repository)

For data output structure please reference the table below.

Header	Description	Structure
0x000D	Temperature: 1024 pixel temperature values followed by PTAT and CRC32. Temperature data is sent in dK (deci Kelvins).	2B header + 1024 pixels * 2 bytes per pixel + 2B PTAT + 7 * 2B pad + 4B CRC32 Each pixel value is transmitted as two bytes, representing the High Byte and the Low Byte of the pixel value. Low Byte first and High Byte second.
N/A	CRC32: verifies integrity only for temperature data. Excludes header and itself.	32 bit unsigned integer * 1 The CRC is transmitted as 2 unsigned 16 bit values (4 bytes total), each of them sent Low Byte first. The first value, when put together, represents the High 16 bits of the 32bit number, while the latter represents the Low 16 bits.

5.5. CRC32 checksum reconstruction

The 32 bit CRC32 checksum is split into two unsigned 16 bit values that are received the same way as a pixel: Low bits first. As shown in the following illustration ([Figure 19](#)), the first value received will represent the 16 upper bits of the 32 bit checksum. To reconstruct the checksum, please use the following formulas:

CRC32 high 16 = (CRC part 1 High Byte << 8) | CRC part 1 Low Byte

CRC32 low 16 = (CRC part 2 High Byte << 8) | CRC part 2 Low Byte

CRC32 = [(CRC32 high 16 & 0xFFFF) << 16] | (CRC32 low 16 & 0xFFFF)

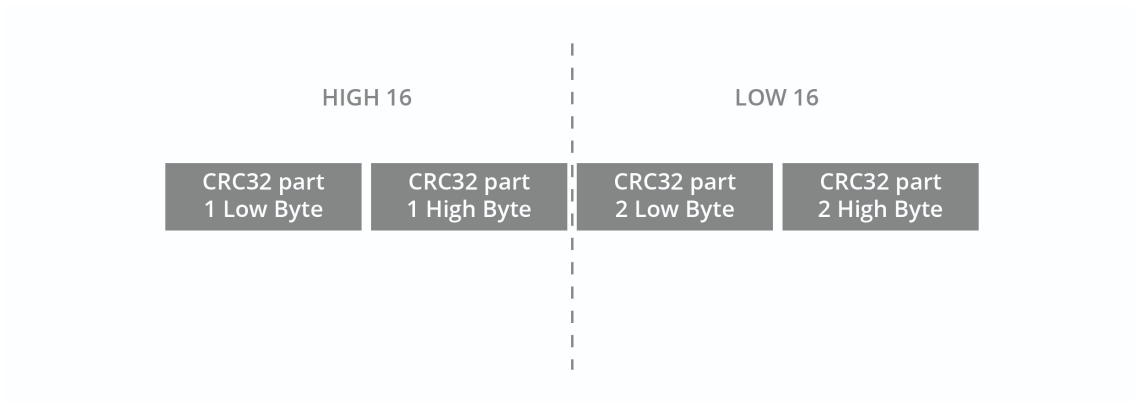

Figure 19. CRC32 High 16 and Low 16

Reconstruction example:

CRC32 part 1 Low Byte = 26
 CRC32 part 1 High Byte = 143
 CRC32 part 2 Low Byte = 55
 CRC32 part 2 High Byte = 182

CRC32 high 16 = $(143 \ll 8) \mid 26 = 36\ 634$
 CRC32 low 16 = $(182 \ll 8) \mid 55 = 46\ 647$

CRC32 = $[(36\ 634 \& 0xFFFF) \ll 16] \mid (46\ 647 \& 0xFFFF)$
 CRC32 = $2\ 400\ 845\ 824 \mid 46\ 647$
 CRC32 = $2\ 400\ 892\ 471$

6. Compliance

RoHS	CE
Yes	Yes

Appendix

A.1. CRC validation

When using python, you will find a dedicated module named '**crcmod**'. Please install the module using '**pip**' with the following command:

```
pip install crcmod
```

A.1.1. How to calculate CRC8 checksum for Evo Thermal

After defining this function:

```
self.crc8 = crcmod.predefined.mkPredefinedCrcFun('crc-8')
```

You will be able to use the above function on any buffer, as illustrated in the code below. In this case 'ack' variable is a 4-byte buffer containing an ACK response.

```
crc = self.crc8(ack[:3])
    if crc == ord(ack[3]): # Check that CRC's are matching
        ...
```

A.1.2 How to calculate CRC32 checksum for Evo Thermal

After defining this function:

```
self.crc32 = crcmod.predefined.mkPredefinedCrcFun('crc-32-mpeg')
```

The following function reads a full frame from the Evo Thermal and validates the CRC32 checksum:

```
def get_thermals(self):
    got_frame = False
    while not got_frame:
        with self.serial_lock:
            ### Polls for header ###
            header = self.port.read(2)
            header = unpack('H', str(header))
            if header[0] == 13:
                ### Header received, now read rest of frame ###
                data = self.port.read(2068)
                ### Calculate CRC for frame (except CRC value and
header) ###
```

```

        calculatedCRC = self.crc32(data[:2064])
        data = unpack("H" * 1034, str(data))
        receivedCRC = (data[1032] & 0xFFFF ) << 16
        receivedCRC |= data[1033] & 0xFFFF
        TA = data[1024]
        data = data[:1024]
        data = np.reshape(data, (32, 32))
        ### Compare calculated CRC to received CRC ###
        if calculatedCRC == receivedCRC:
            got_frame = True
        else:
            print "Bad CRC. Dropping frame"

self.port.flushInput()
### Data is sent in dK, this converts it to celsius ###
data = (data/10.0) - 273.15
TA = (TA/10.0) - 273.15

return data

```

A.2. Sample code

Please follow the link below to connect to Terabee's sample code repository on GitHub. The following python sample code provides basic sensor functionality and communication, including activating data output, reading data and validating the CRC checksum.

https://github.com/Terabee/sample_codes

The name TERABEE® and the  ® are registered trademarks in the following countries: China, European Union, France, South Korea, Switzerland, Taiwan, United Kingdom and United States.

Terabee reserves the right to make changes, corrections, modifications or improvements to this document, and the products and services described herein at any time, without notice.